

SICK.COM



DATA SHEET

# GTB6-P4212

G6  
Photoelectric sensors

**SICK** Sensor Intelligence

## PHOTOELECTRIC SENSORS

## GTB6-P4212

## ORDERING INFORMATION

| Type       | part no. |
|------------|----------|
| GTB6-P4212 | 1052442  |

Further device versions and accessories at [www.sick.com/G6](http://www.sick.com/G6)



Illustration may differ



## DETAILED TECHNICAL DATA

## FEATURES

|                             |                                                          |                             |
|-----------------------------|----------------------------------------------------------|-----------------------------|
| Functional principle        | Photoelectric proximity sensor                           |                             |
| Functional principle detail | Background suppression                                   |                             |
| Sensing range max.          | 5 mm ... 250 mm <sup>1)</sup>                            |                             |
| Sensing range               | 35 mm ... 140 mm                                         |                             |
| Emitted beam                | Light source                                             | PinPoint LED <sup>2)</sup>  |
|                             | Type of light                                            | Visible red light           |
|                             | Light spot size (distance)                               | Ø 6 mm (100 mm)             |
| Key LED figures             | Wave length                                              | 650 nm                      |
|                             | Adjustment                                               | Mechanical spindle, 5 turns |
| Items supplied              | Stainless steel mounting bracket (1.4301/304) BEF-W100-A |                             |

<sup>1)</sup> Object with 90% remission (based on standard white, DIN 5033).

<sup>2)</sup> Average service life: 100,000 h at T<sub>u</sub> = +25 °C.

## SAFETY-RELATED PARAMETERS

|                   |             |
|-------------------|-------------|
| MTTF <sub>D</sub> | 1,886 years |
| DC <sub>avg</sub> | 0 %         |

**ELECTRONICS**

|                      |                                                                                                                                                                                                                                                                                                                                                                                                                                                           |
|----------------------|-----------------------------------------------------------------------------------------------------------------------------------------------------------------------------------------------------------------------------------------------------------------------------------------------------------------------------------------------------------------------------------------------------------------------------------------------------------|
| Supply voltage $U_B$ | 10 V DC ... 30 V DC <sup>1)</sup>                                                                                                                                                                                                                                                                                                                                                                                                                         |
| Ripple               | $\pm 10\%$ <sup>2)</sup>                                                                                                                                                                                                                                                                                                                                                                                                                                  |
| Current consumption  | 30 mA <sup>3)</sup>                                                                                                                                                                                                                                                                                                                                                                                                                                       |
| Protection class     | III                                                                                                                                                                                                                                                                                                                                                                                                                                                       |
| Digital output       | <p>Type PNP</p> <p>Switching mode Light/dark switching</p> <p>Switching mode selector Selectable via light/dark selector</p> <p>Signal voltage PNP HIGH/LOW <math>V_S - (\leq 3\text{ V}) / \text{approx. } 0\text{ V}</math></p> <p>Output current <math>I_{\text{max}}</math> <math>\leq 100\text{ mA}</math> <sup>4)</sup></p> <p>Response time <math>&lt; 625\ \mu\text{s}</math> <sup>5)</sup></p> <p>Switching frequency 1,000 Hz <sup>6)</sup></p> |
| Circuit protection   | A <sup>7)</sup><br>B <sup>8)</sup><br>D <sup>9)</sup>                                                                                                                                                                                                                                                                                                                                                                                                     |

<sup>1)</sup> Limit values when operated in short-circuit protected network: max. 8 A.

<sup>2)</sup> May not fall below or exceed  $U_B$  tolerances.

<sup>3)</sup> Without load.

<sup>4)</sup> At  $U_B > 24\text{ V}$ ,  $I_A \text{ max.} = 50\text{ mA}$ .

<sup>5)</sup> Signal transit time with resistive load.

<sup>6)</sup> With light/dark ratio 1:1.

<sup>7)</sup> A =  $V_S$  connections reverse-polarity protected.

<sup>8)</sup> B = inputs and output reverse-polarity protected.

<sup>9)</sup> D = outputs overcurrent and short-circuit protected.

**MECHANICS**

|                        |                                                                  |
|------------------------|------------------------------------------------------------------|
| Housing                | Rectangular                                                      |
| Dimensions (W x H x D) | 12 mm x 31.5 mm x 21 mm                                          |
| Connection             | Male connector M8, 4-pin                                         |
| Material               | <p>Housing Plastic, ABS/PC</p> <p>Front screen Plastic, PMMA</p> |
| Weight                 | 20 g                                                             |

**AMBIENT DATA**

|                               |                                                                           |
|-------------------------------|---------------------------------------------------------------------------|
| Enclosure rating              | IP67                                                                      |
| Ambient operating temperature | $-25\text{ }^\circ\text{C} \dots +55\text{ }^\circ\text{C}$ <sup>1)</sup> |
| Ambient temperature, storage  | $-40\text{ }^\circ\text{C} \dots +70\text{ }^\circ\text{C}$               |
| UL File No.                   | NRKH.E348498 & NRKH7.E348498                                              |

<sup>1)</sup> Temperature stability following adjustment  $\pm 10\text{ }^\circ\text{C}$ .

**CERTIFICATES**

|                                |   |
|--------------------------------|---|
| EU declaration of conformity   | ✓ |
| UK declaration of conformity   | ✓ |
| ACMA declaration of conformity | ✓ |

|                                                     |   |
|-----------------------------------------------------|---|
| Moroccan declaration of conformity                  | ✓ |
| China RoHS                                          | ✓ |
| China Compulsory Product Certification (CCC) exempt | ✓ |
| cULus certificate                                   | ✓ |
| Photobiological safety (DIN EN 62471) certificate   | ✓ |

**DIMENSIONAL DRAWING**

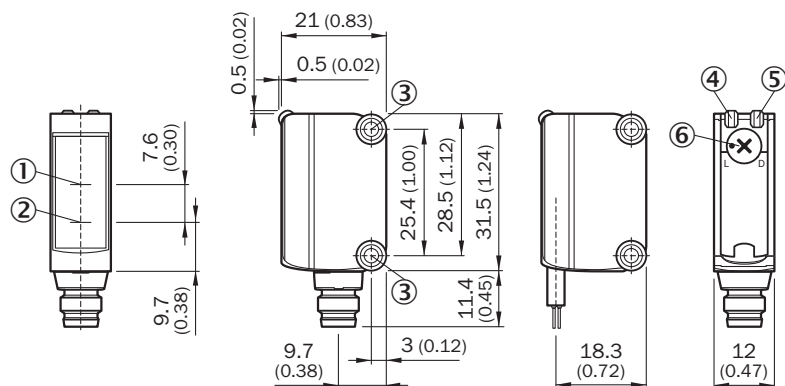

Dimensions in mm (inch)

- ① Optical axis, receiver
- ② Optical axis, sender
- ③ Mounting holes M3
- ④ LED indicator green: Supply voltage active
- ⑤ LED indicator yellow: Status of received light beam
- ⑥ Light/ dark rotary switch: L = light switching, D = dark switching

**ADJUSTMENTS ADJUSTMENT POSSIBILITY**

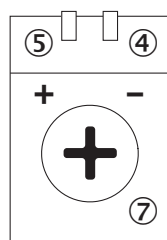

- ④ LED indicator green: Supply voltage active
- ⑤ LED indicator yellow: Status of received light beam
- ⑦ Sensitivity control: potentiometer

**CONNECTION TYPE**

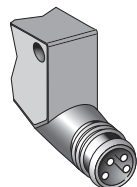

**CONNECTION DIAGRAM CD-066**

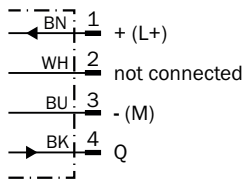

**CHARACTERISTIC CURVE GTB6**

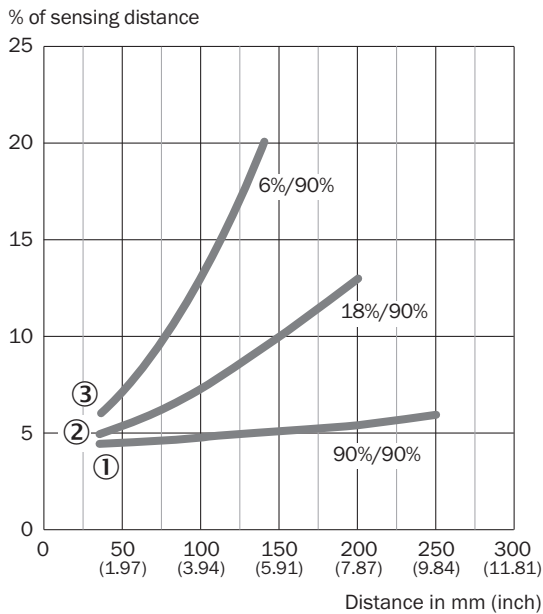

- ① object with 90% remission (based on standard white, DIN 5033)
- ② Sensing range on gray, 18% remission factor
- ③ Sensing range on black, 6% remission factor

**LIGHT SPOT SIZE GTB6**

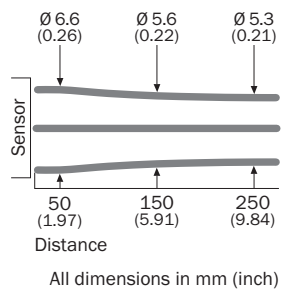

**SENSING RANGE DIAGRAM GTB6**

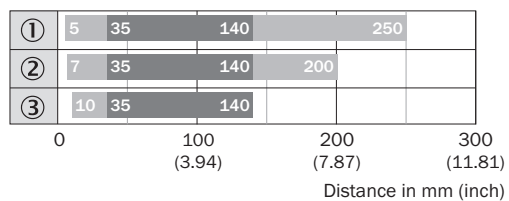

- Sensing range max.
- Sensing range
- ① object with 90% remission (based on standard white, DIN 5033)
- ② Sensing range on gray, 18% remission factor
- ③ Sensing range on black, 6% remission factor

Further information as well as suitable accessories, example applications and downloads such as CAD dimensional models, operating instructions and software can be found at [www.sick.com/1052442](http://www.sick.com/1052442)



SICK AG  
WALDKIRCH  
GERMANY  
SICK.COM

# SICK AT A GLANCE

SICK is a leading global technology company for intelligent sensors and integrated solutions in industrial automation. Our technologies set benchmarks, making your industrial processes more efficient, safer and more sustainable – both in logistics and manufacturing operations.

SICK combines sensor intelligence with industry expertise and certified consulting services. We provide the ideal foundation for scalable as well as tailor-made automation solutions and create added value along the entire value chain. Our close partnerships with our customers are more than just a promise: Together, we optimize productivity, improve quality, protect health and safety, and help build a sustainable future. All with empathy and trust.

Since 1946, we have been developing innovative technologies with passion and a pioneering spirit. With a global network in around 40 countries, SICK has a global presence and is always close by. The company's headquarters are located in Waldkirch near Freiburg, Germany. Our customers benefit from our understanding of both local and global requirements, which enables us to deliver tailor-made solutions

**SICK**  
Sensor Intelligence