



CM12-08EBO-KC1

CM

CAPACITIVE PROXIMITY SENSORS

SICK
Sensor Intelligence.



Ordering information

Type	part no.
CM12-08EBO-KC1	6078709

Other models and accessories → www.sick.com/CM

Illustration may differ



Detailed technical data

Features

Housing	Metric
Thread size	M12 x 1
Diameter	Ø 12 mm
Sensing range S_n	0.5 mm ... 8 mm ¹⁾ 0.5 mm ... 4 mm ²⁾
Safe sensing range S_a	5.76 mm
Installation type	Non-flush / flush ³⁾
Switching frequency	15 Hz
Connection type	Male connector M12, 4-pin
Switching output	PNP / NPN
Switching output detail	PNP / NPN
Output function	NC or NO
Output characteristic	Wire configurable ⁴⁾
Electrical wiring	DC 4-wire
Adjustment	
	Teach-in button
	Wire/pin
	Sensitivity
	Sensitivity
Enclosure rating	IP68 (According to EN 60529) ⁵⁾
Special features	Output function programmable (factory setting: normally closed contact)
Items supplied	Mounting nut, PA12 plastic (2x)

¹⁾ For non-flush installation.

²⁾ For flush mounting.

³⁾ For flush mounting, Teach-in necessary.

⁴⁾ Automatic detection.

⁵⁾ 1.3 m water depth / 60 min.

Mechanics/electronics

Supply voltage	10 V DC ... 36 V DC
Ripple	≤ 10 % ¹⁾
Voltage drop	≤ 2.5 V DC ²⁾
Current consumption	12 mA ³⁾
Time delay before availability	≤ 120 ms
Hysteresis	3 % ... 20 %
Reproducibility	≤ 5 % ⁴⁾ ⁵⁾
EMC	According to EN 60947-5-2 ⁶⁾
Continuous current I_a	≤ 200 mA
Short-circuit protection	✓
Power-up pulse protection	✓
Shock and vibration resistance	30 g, 11 ms / 10 ... 55 Hz, 1 mm
Ambient operating temperature	-20 °C ... +85 °C
Ambient temperature, storage	-40 °C ... +85 °C
Housing material	Plastic
Housing length	84.7 mm
Thread length	46.5 mm
Tightening torque, max.	≤ 1 Nm
UL File No.	NRKH.E191603

¹⁾ Of U_B.

²⁾ At I_a max.

³⁾ Without load.

⁴⁾ Of S_r.

⁵⁾ Supply voltage U_B and constant ambient temperature T_a.

⁶⁾ For non-flush installation min. 1 x S_n and sensor grounded.

Safety-related parameters

MTTF_D	607 years
DC_{avg}	0 %
T_M (mission time)	20 years

Reduction factors

Note	The values are reference values which may vary
Metal	1
Water	1
PVC	Approx. 0.4
Oil	Approx. 0.25
Glass	0.6
Ceramics	0.5
Alcohol	0.7
Wood	0.2 ... 0.7

Installation note

Remark	Associated graphic see "Installation"
A	8 mm
B	12 mm
C	12 mm
D	12 mm
E	8 mm
F	6 x S _n (max. 48 mm)

Certificates

EU declaration of conformity	✓
UK declaration of conformity	✓
Moroccan declaration of conformity	✓
China RoHS	✓
cULus certificate	✓

Classifications

ECLASS 5.0	27270102
ECLASS 5.1.4	27270102
ECLASS 6.0	27270102
ECLASS 6.2	27270102
ECLASS 7.0	27270102
ECLASS 8.0	27270102
ECLASS 8.1	27270102
ECLASS 9.0	27270102
ECLASS 10.0	27270102
ECLASS 11.0	27270102
ECLASS 12.0	27274201
ETIM 5.0	EC002715
ETIM 6.0	EC002715
ETIM 7.0	EC002715
ETIM 8.0	EC002715
UNSPSC 16.0901	39122230

Installation note Non-flush installation



Connection diagram Cd-235

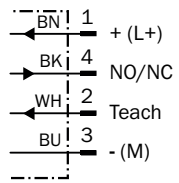

Response diagram CM12

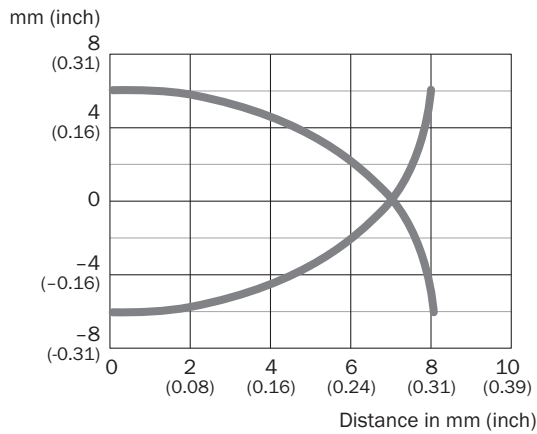

Dimensional drawing CM12, connector

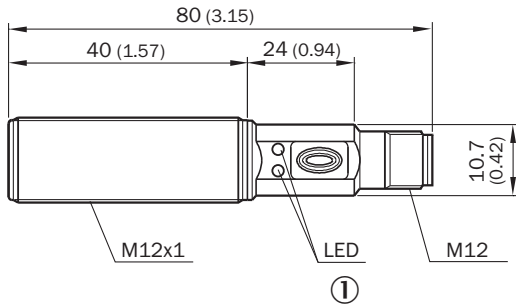









Dimensions in mm (inch)

① LED yellow: output active; LED green: Power and signal reserve

Recommended accessories

Other models and accessories → www.sick.com/CM

	Brief description	Type	part no.
Mounting systems			
	<ul style="list-style-type: none"> Description: Mounting plate for M12 sensors Material: Steel Details: Steel, zinc coated Items supplied: Without mounting hardware 	BEF-WG-M12	5321869
	<ul style="list-style-type: none"> Description: Mounting bracket for M12 sensors Material: Steel Details: Steel, zinc coated Items supplied: Without mounting hardware 	BEF-WN-M12	5308447
	<ul style="list-style-type: none"> Description: Plate N05 for universal clamp bracket, M12 Material: Steel, zinc diecast Details: Zinc plated steel (sheet), Zinc die cast (clamping bracket) Items supplied: Universal clamp (5322626), mounting hardware Usable for: IMA, IMF, M12 round sensors, UC4, V12-2, MultiV, MultiLine, W4-3, MultiV, MultiLine 	BEF-KHS-N05	2051611

	Brief description	Type	part no.
connectors and cables			
	<ul style="list-style-type: none"> Description: Unshielded Connection type head A: Female connector, M12, 4-pin, straight, A-coded Connection systems: Screw-type terminals Permitted cross-section: ≤ 0.75 mm² 	DOS-1204-G	6007302
	<ul style="list-style-type: none"> Description: Unshielded Connection type head A: Female connector, M12, 4-pin, angled, A-coded Connection systems: Screw-type terminals Permitted cross-section: ≤ 0.75 mm² 	DOS-1204-W	6007303
	<ul style="list-style-type: none"> Description: Sensor/actuator cable, unshielded Connection type head A: Female connector, M12, 4-pin, angled, A-coded Connection type head B: Flying leads Signal type: Sensor/actuator cable Cable: 0.6 m, 4-wire, PVC Application: Uncontaminated zones, Zones with chemicals 	YG2A14-C60VB3XLEAX	2145709
	<ul style="list-style-type: none"> Description: Sensor/actuator cable, unshielded Connection type head A: Female connector, M12, 4-pin, angled, A-coded Connection type head B: Flying leads Signal type: Sensor/actuator cable Cable: 1 m, 4-wire, PVC Application: Uncontaminated zones, Zones with chemicals 	YG2A14-010VB3XLEAX	2145710
	<ul style="list-style-type: none"> Description: Sensor/actuator cable, unshielded Connection type head A: Female connector, M12, 4-pin, straight, A-coded Connection type head B: Flying leads Signal type: Sensor/actuator cable Cable: 0.6 m, 4-wire, PVC Application: Uncontaminated zones, Zones with chemicals 	YF2A14-C60VB3XLEAX	2145707
	<ul style="list-style-type: none"> Description: Sensor/actuator cable, unshielded Connection type head A: Female connector, M12, 4-pin, straight, A-coded Connection type head B: Flying leads Signal type: Sensor/actuator cable Cable: 1 m, 4-wire, PVC Application: Uncontaminated zones, Zones with chemicals 	YF2A14-010VB3XLEAX	2145708

SICK AT A GLANCE

SICK is one of the leading manufacturers of intelligent sensors and sensor solutions for industrial applications. A unique range of products and services creates the perfect basis for controlling processes securely and efficiently, protecting individuals from accidents and preventing damage to the environment.

We have extensive experience in a wide range of industries and understand their processes and requirements. With intelligent sensors, we can deliver exactly what our customers need. In application centers in Europe, Asia and North America, system solutions are tested and optimized in accordance with customer specifications. All this makes us a reliable supplier and development partner.

Comprehensive services complete our offering: SICK LifeTime Services provide support throughout the machine life cycle and ensure safety and productivity.

For us, that is “Sensor Intelligence.”

WORLDWIDE PRESENCE:

Contacts and other locations –www.sick.com